



# 高身发饱柜

编号: \_\_\_\_\_

数量: \_\_\_\_\_

工程名称: \_\_\_\_\_

## 产品特点

利高高身发饱柜采用全不锈钢制造，电子控制。根据规格可分为：单门16盘和32盘，推入式（单门及双门）和冷冻延时发饱柜。

## 功能特性

### 电热发饱柜

- 轻触式微电脑控制，设有显示功能
- 醒发时间：0~99分钟可调
- 醒发温度：小于50℃可调
- 醒发湿度：小于99%可调
- 含水垢磁化管

### 冷冻延时发饱柜

- 24小时延时设定，可选择冷冻及发饱时间
- 全自动智能工作，冷冻-解冻-醒发，轻松完成
- 采用优质进口压缩机，制冷性能稳定
- 冷冻温度：-12℃~+5℃可调
- 醒发温度：小于50℃可调
- 醒发湿度：小于99%可调
- 含水垢磁化管

\* 注意事项：硬水地区使用必须配置软化水设置



□ PR-4060-P16  
高身单门发饱柜  
(单盘直放)



□ PR-4060-P32  
高身单门发饱柜  
(双盘横放)



□ PR-4060-1P/2VP  
推入式发饱柜 (单门)



□ PR-4060-2P  
推入式发饱柜 (双门)



□ PR-4060-1F/2VF  
推入式冷冻发饱柜  
(单门)



□ PR-4060-2F  
推入式冷冻发饱柜  
(双门)



# 高身发饱柜



生产许可证(QS)  
编号: 粤XK01-302-00079

## 规格参数

型号	尺寸(毫米)			电压	耗电量 (千瓦)	饼盘尺寸(毫米) 饼盘车及数量
	W	D	H			
PR-4060-P16	560	775	2100	220V/SPN/50Hz	1.5	400x600;16
PR-4060-P32	760	980	2100	220V/SPN/50Hz	1.5	400x600;32
PR-4060-1P	920	1020	2300	220V/SPN/50Hz	2	400x600;16(1台)
PR-4060-1F	920	1020	2300	380V/TPN/50Hz	3	400x600;16(1台)
PR-4060-2VP	920	1700	2300	220V/SPN/50Hz	2	400x600;32(2台)
PR-4060-2VF	920	1700	2300	380V/TPN/50Hz	3.5	400x600;32(2台)
PR-4060-2P	1760	1020	2300	220V/SPN/50Hz	2	400x600;32(2台)
PR-4060-2F	1760	1020	2300	380V/TPN/50Hz	3.5	400x600;32(2台)

\*规格更改无需另行通知

## 可选配件

### PR-4060-P16

- 400x600x30mmH饼盘16个

### PR-6040-1P

- 饼盘车(PT4060-16) 1台
- 400x600x30mmH饼盘16个

### PR-4060-2VP

- 饼盘车(PT4060-16) 2台
- 400x600x30mmH饼盘32个

### PR-4060-2P

- 饼盘车(PT4060-16) 2台
- 400x600x30mmH饼盘32个

### PR-4060-P32

- 400x600x30mmH饼盘32个

### PC-4060-1F

- 饼盘车(PT4060-16) 1台
- 400x600x30mmH饼盘16个

### PR-4060-2VF

- 饼盘车(PT4060-16) 2台
- 400x600x30mmH饼盘32个

### PR-4060-2F

- 饼盘车(PT4060-16) 2台
- 400x600x30mmH饼盘32个

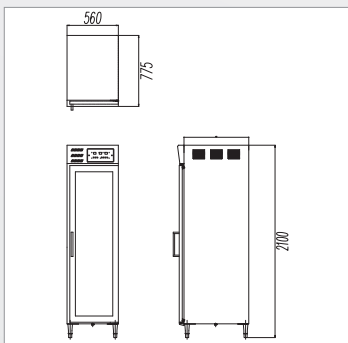

PR-4060-P16

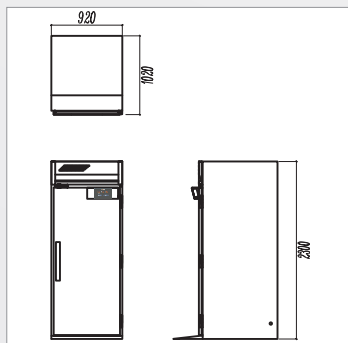

PR-4060-1P

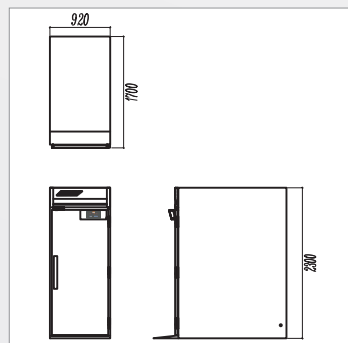

PR-4060-2VP

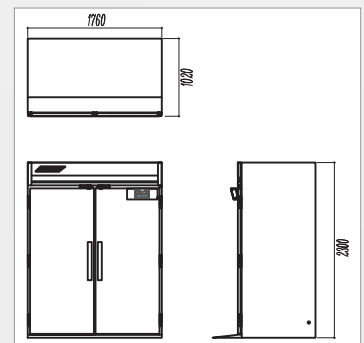

PR-4060-2P

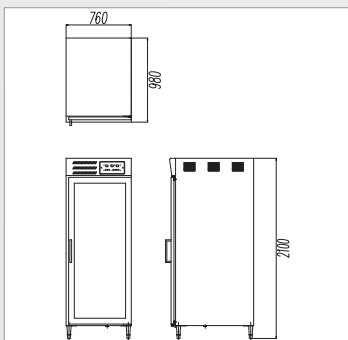

PR-4060-P32

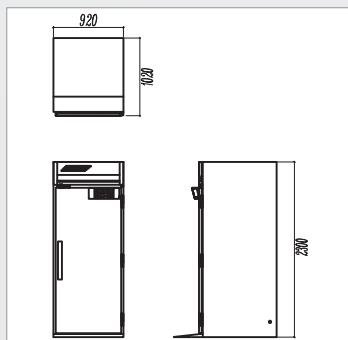

PR-4060-1F

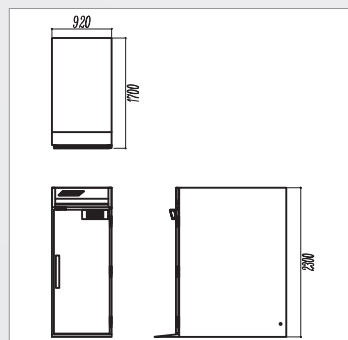

PR-4060-2VF

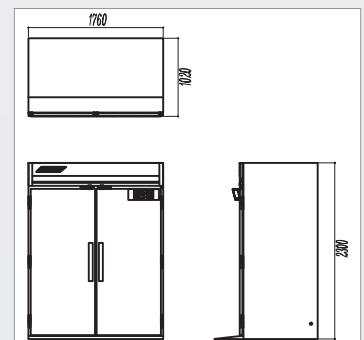

PR-4060-2F



裕富宝厨具设备(深圳)有限公司  
Yu Fu Bao Kitchenware Equipment (Shenzhen) Co., Ltd.  
深圳市龙岗区龙岗街道爱南路348号保成泰吉祥产业园A栋501室

TEL: 0755-84712229

E-MAIL: szfac@yufubao-cn.com

WEBSITE: www.yufubao-cn.com

(生产基地: 惠州市惠阳区平潭镇独石村(怡发工业区)厂房一、厂房二、厂房三)